

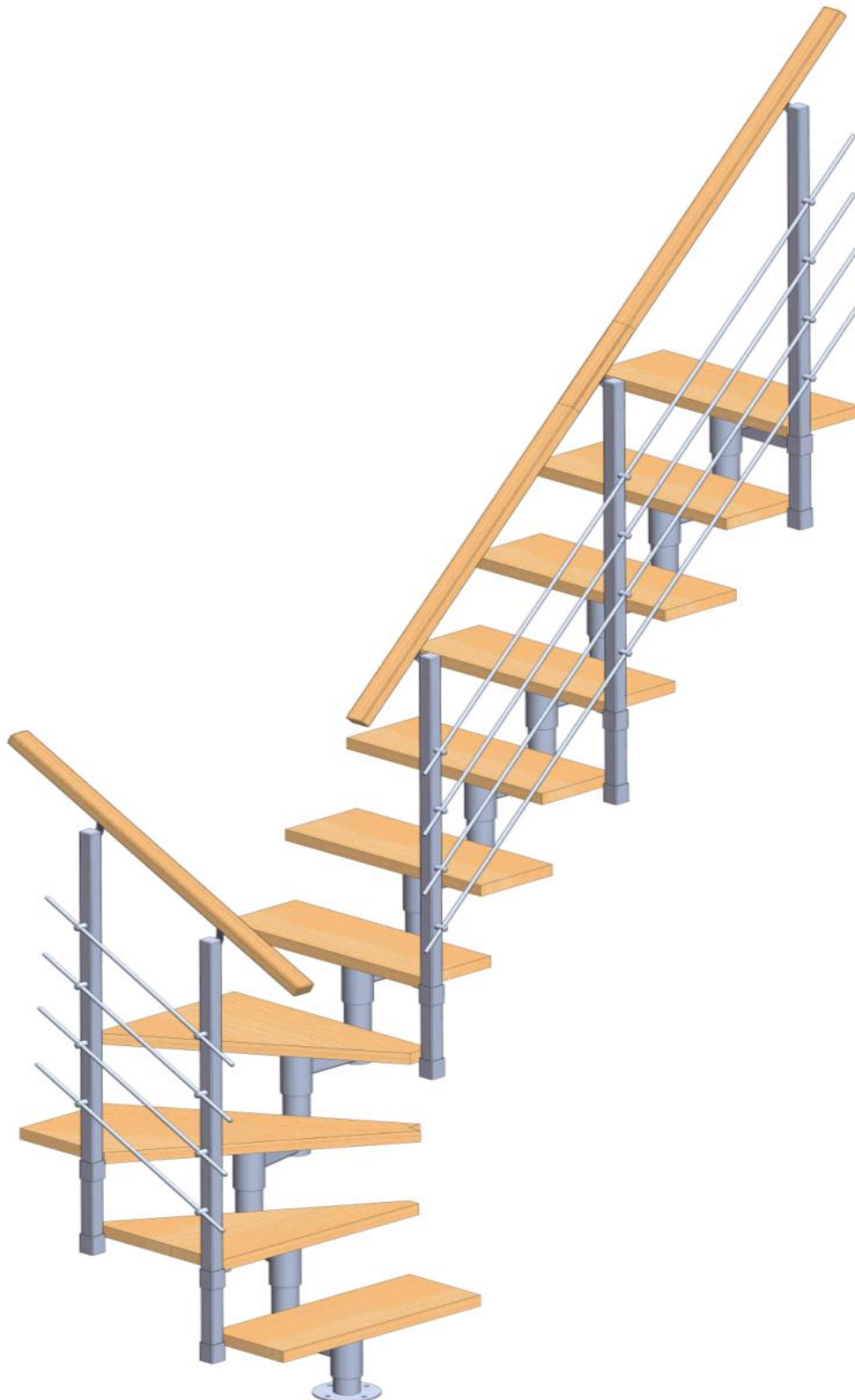

Upstairs24
WE ARE STAIRS











Escalier York



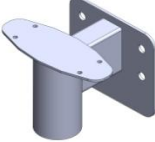







Liste de pièces YORK



Nombre de marches - 11

max. Hauteur de l'étage 280 cm

1. Vis  Nombre : 63 6x25	7.  Nombre : 20	13.  Nombre : 1
2.  Nombre : 18 4,5x25	8.  Nombre : 10	14.  Nombre : 10
3.  Nombre : 20 M6x5	9.  Nombre : 1	15.  Nombre : 5
4.  Nombre : 24 M10x8	10.  Nombre : 1	16.  Nombre : 1
5.  Nombre : 20 M6x50	11.  Nombre : 3	17.  Nombre : 4
6.  Nombre : 20 M6	12.  Nombre : 1	18.  Nombre : 2

<p>19.</p> <p>Nombre : 3</p> 	<p>20.</p> <p>Nombre : 8</p> 	<p>21.</p> <p>Nombre : 1</p> 
<p>22.</p> <p>Nombre : 1</p> 	<p>23.</p> <p>Nombre : 1</p> 	<p>24.</p> <p>Nombre : 5</p> 
<p>25.</p> <p>Nombre : 20</p> 	<p>26.</p> <p>Nombre : 5</p> 	<p>27.</p> <p>Nombre : 12</p> 

Outillage nécessaire

 <p>SW10</p>	 <p>Ø 5mm</p>	 <p>SW 3/5</p>
		

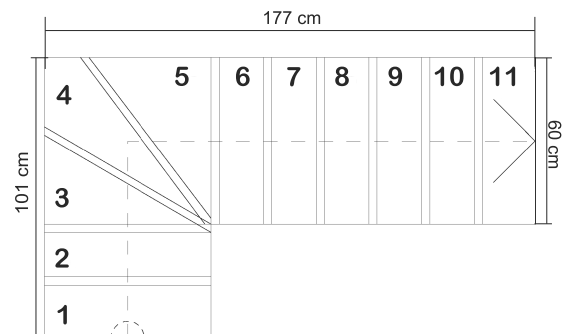
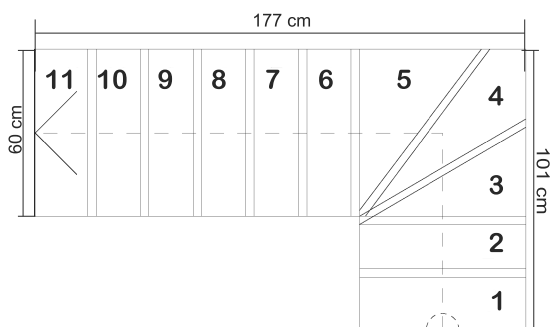
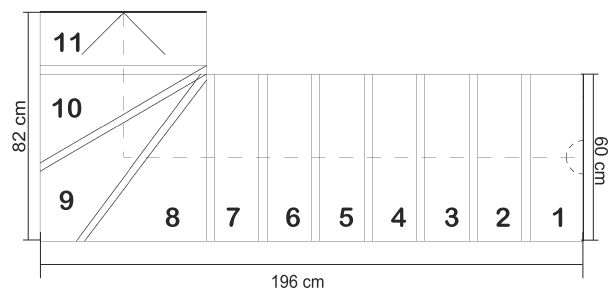
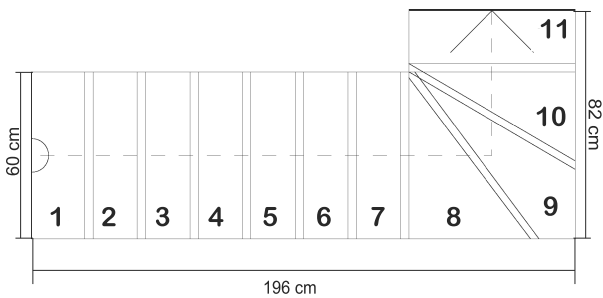
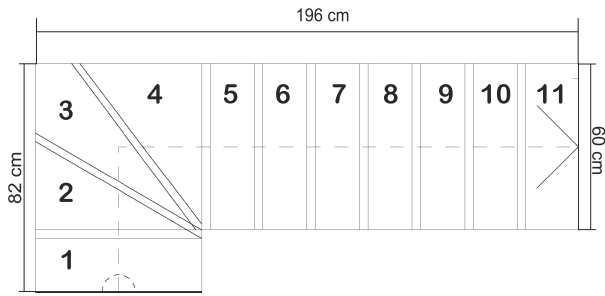
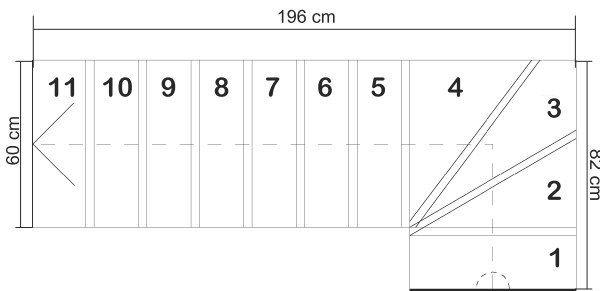
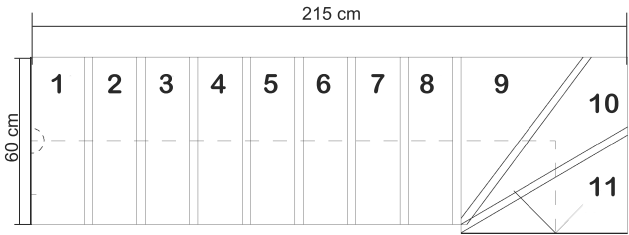
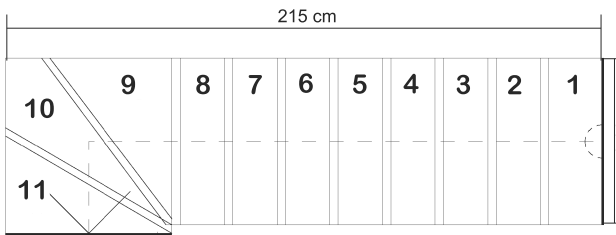
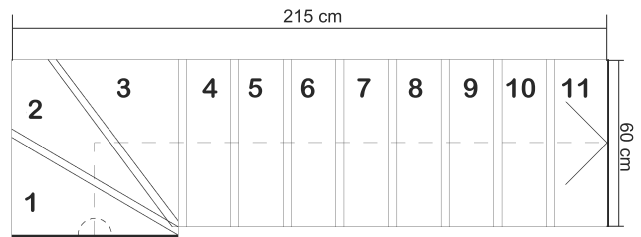
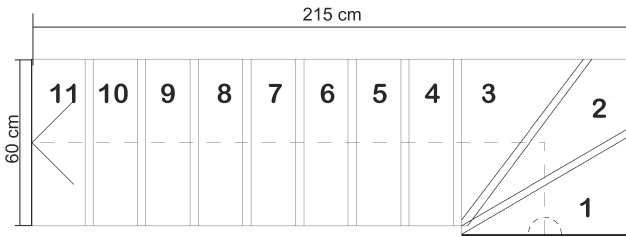

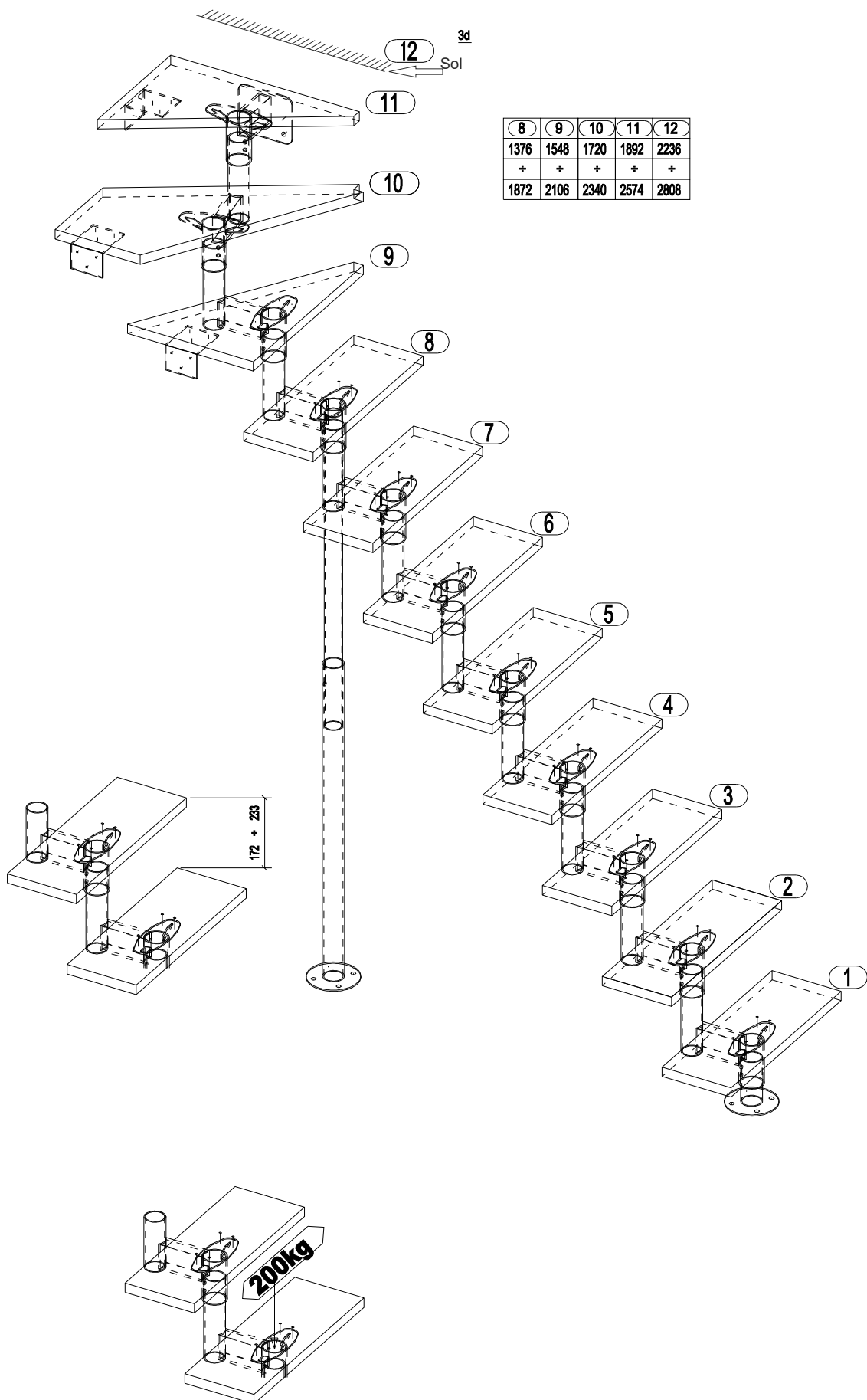

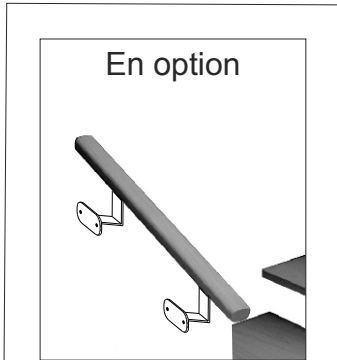

Si vous n'avez pas la place de monter les supports de la rampe sur le support le plus court vous pouvez également fixer directement la main courante au mur. (18)

Fixation de la rampe
Voir illustration "2.5 2.6"
Page 8.

Fixation de la main courante
aux supports de la rampe
Voir illustration "2.4"
Page 8.

Réglage en hauteur
de la marche
Voir illu. "1.2" Page 7.

Fixation des supp.
de la rampe
Voir illu. "1.3-1.6"
Page 7.

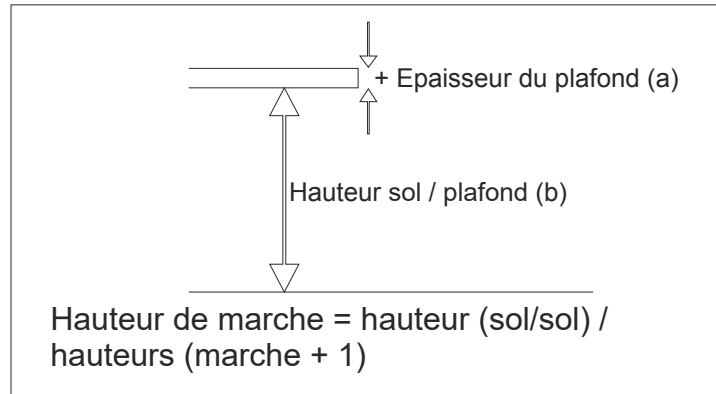

Fixation des supp.
de la rampe
Voir illu. "1.3-1.6"
Page 7.

Fixation des supp.
de la rampe
Voir illu. "1.3-1.6"
Page 7.

Fixation au mur de l'escalier:

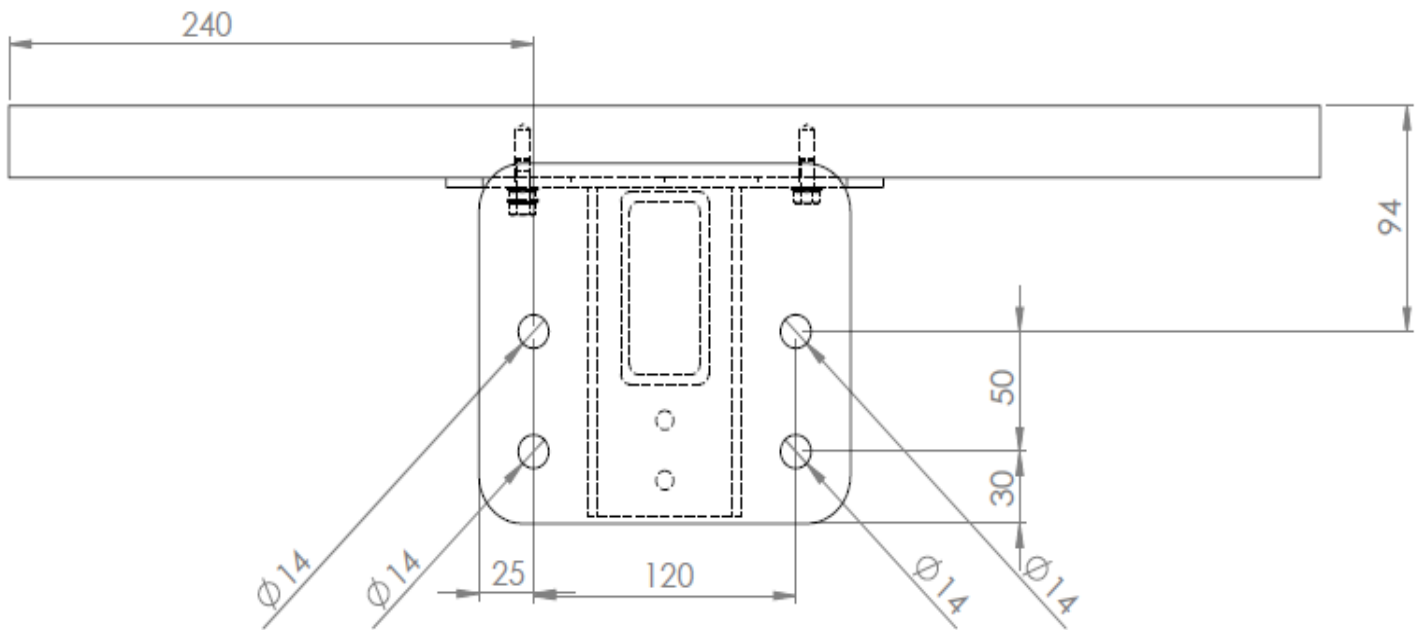

Fixation au sol de l'escalier:

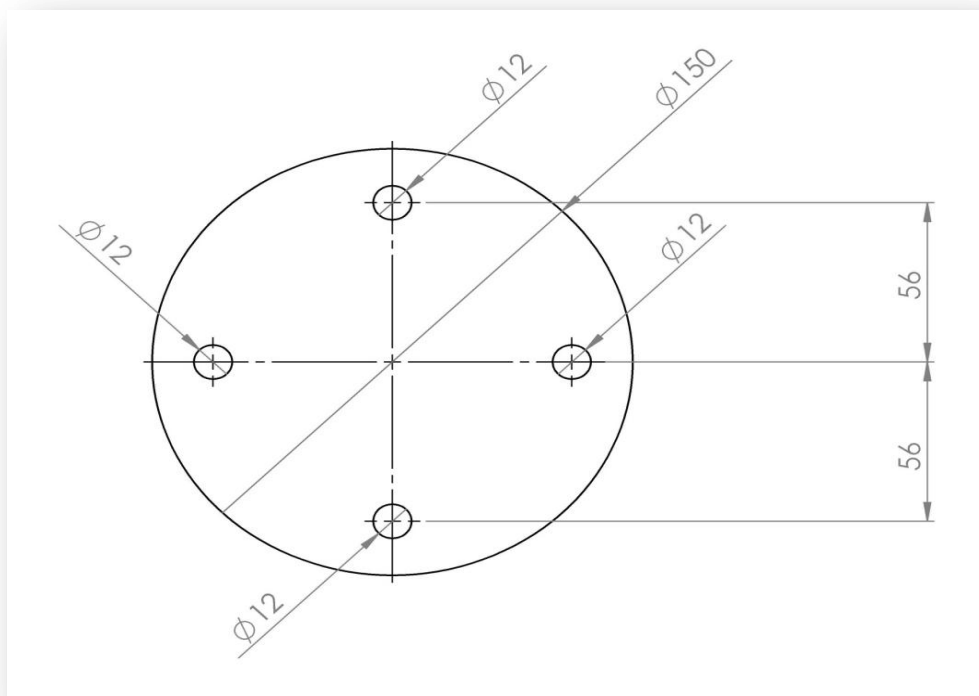

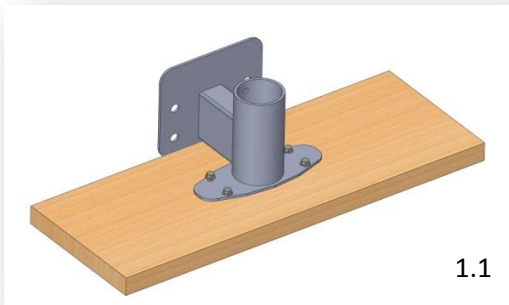

Veillez à ne pas endommager les vis de fixation car elles n'assureraient plus la stabilité nécessaire.

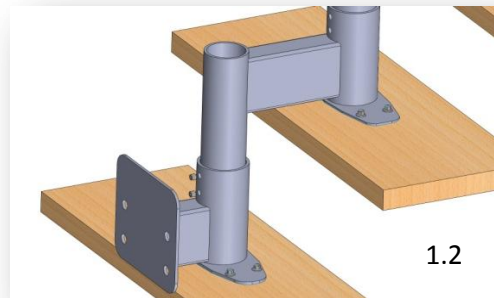

Lors du montage des goujons filetés sans têtes veillez à ne pas endommager la surface peinte.
Lors du positionnement définitif de l'escalier vérifiez le serrage correct de toutes les vis.

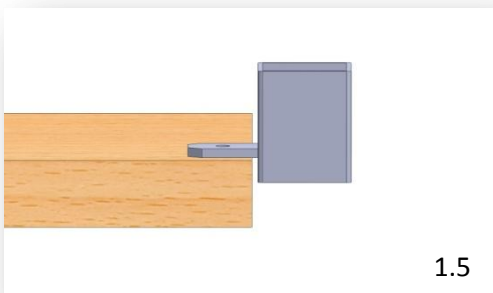
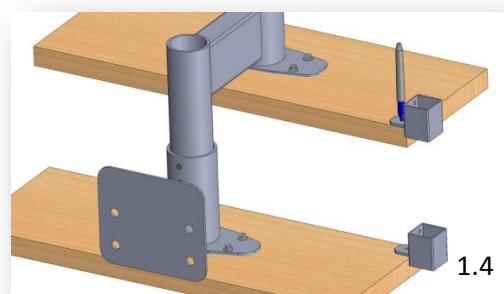
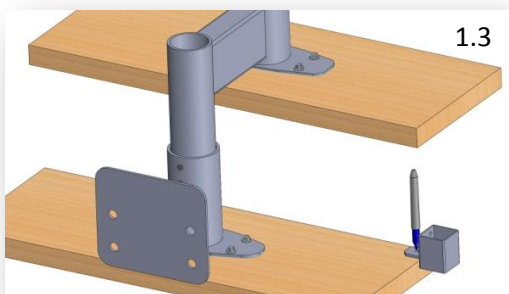

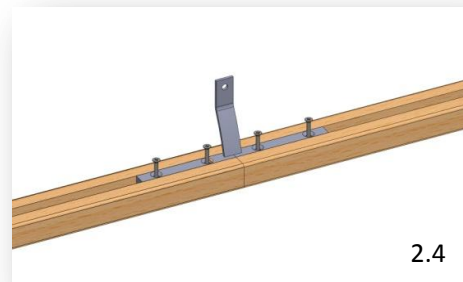
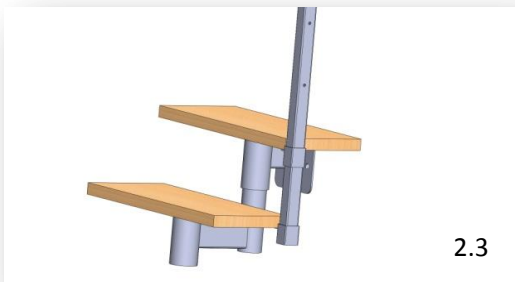
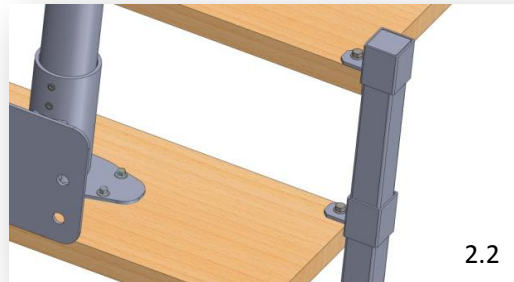
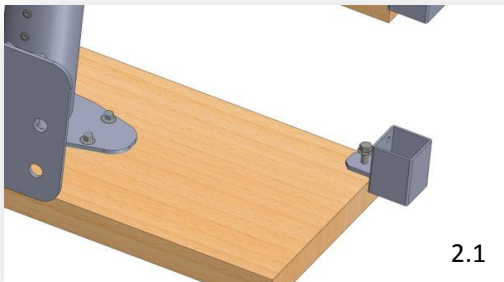

Montage de la rampe

Choisissez la position des montants de la rampe (toujours fixée à 2 marches). (voir illustration 2.2. 2.3.)

Le montant médian de la rampe doit être positionné de manière à ce que les supports de la main courante (16) puissent être fixés à l'aide de la pièce fournie. (voir illustration 2.4.)

Lorsque vous déterminerez la position des montants de la rampe (14) veillez à ce que les montants de la rampe soient parfaitement verticaux. Lors du perçage des marches, veillez à ne pas percer trop profondément. (voir illustration 1.6.)

Procédez tout d'abord à l'adaptation et au positionnement des supports de la rampe (14) avant de serrer définitivement les vis de blocage des supports de la rampe (voir illustration 2.1.)

Faites attention à éviter toute détérioration de la surface

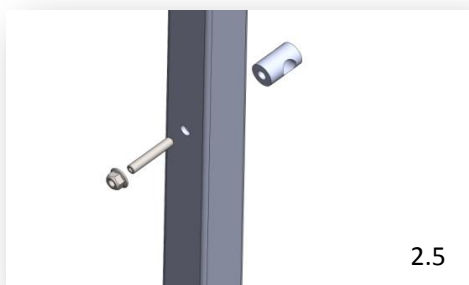

Si dans la variante de rampe que vous avez choisie, les supports de la rampe sont trop longs vous devez les raccourcir. Egalisez l'endroit de la coupe avec un papier-verre fin.

Attention: le matériel nécessaire à la fixation au mur et au sol n'est pas inclus dans la livraison. Les éléments nécessaires doivent être spécifiquement adaptés aux matériaux du mur du sol et du plafond et doivent être achetés dans le commerce spécialisé.