

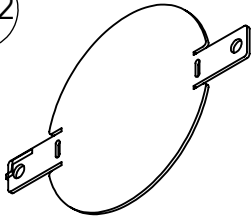

<p>ST12</p>  <p>∅ 60 mm</p> <p>2x</p>	<p>ST54</p>  <p>2x</p>	<p>G06</p>  <p>∅ 40x952mm</p> <p>1x</p>
<p>G10</p>  <p>∅ 40 mm</p> <p>2x</p>	<p>G13</p>  <p>∅ 6x1x1000mm</p> <p>5x</p>	<p>GS19</p>  <p>∅ 22x1,65x978mm</p> <p>3x</p>
<p>D01</p>  <p>∅ 12 mm</p> <p>6x</p>	<p>D02</p>  <p>∅ 8 mm</p> <p>3x</p>	<p>NT11</p>  <p>∅ 4 x 25mm</p> <p>12x</p>
<p>NT19</p>  <p>M8 x 60mm</p> <p>6x</p>	<p>NT26</p>  <p>M8 DIN125</p> <p>6x</p>	<p>NT48</p>  <p>M6</p> <p>3x</p>
<p>NT49</p>  <p>M6</p> <p>3x</p>	 <p>5x</p>	

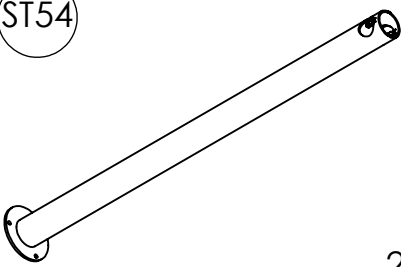

3

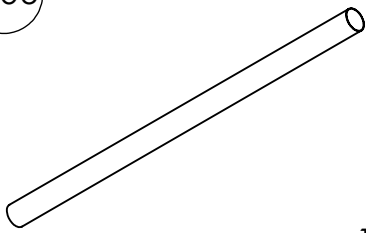
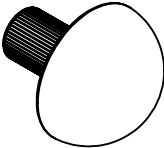
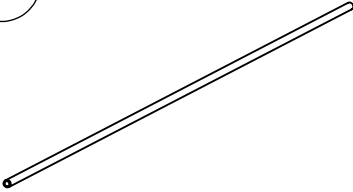
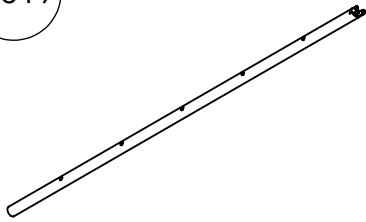
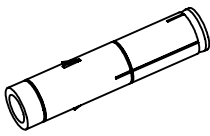
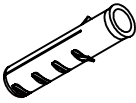
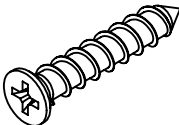
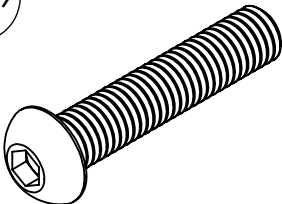
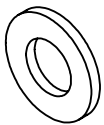

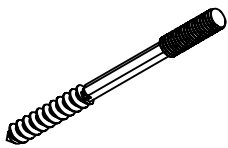
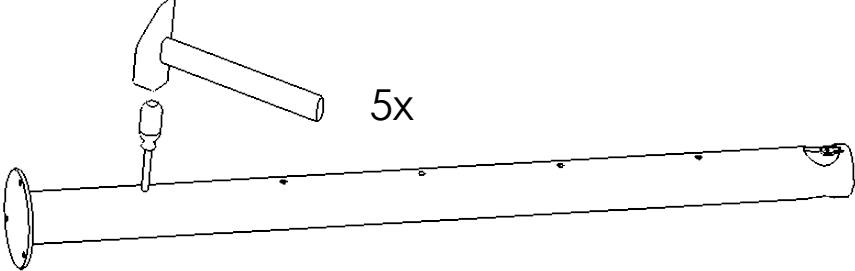
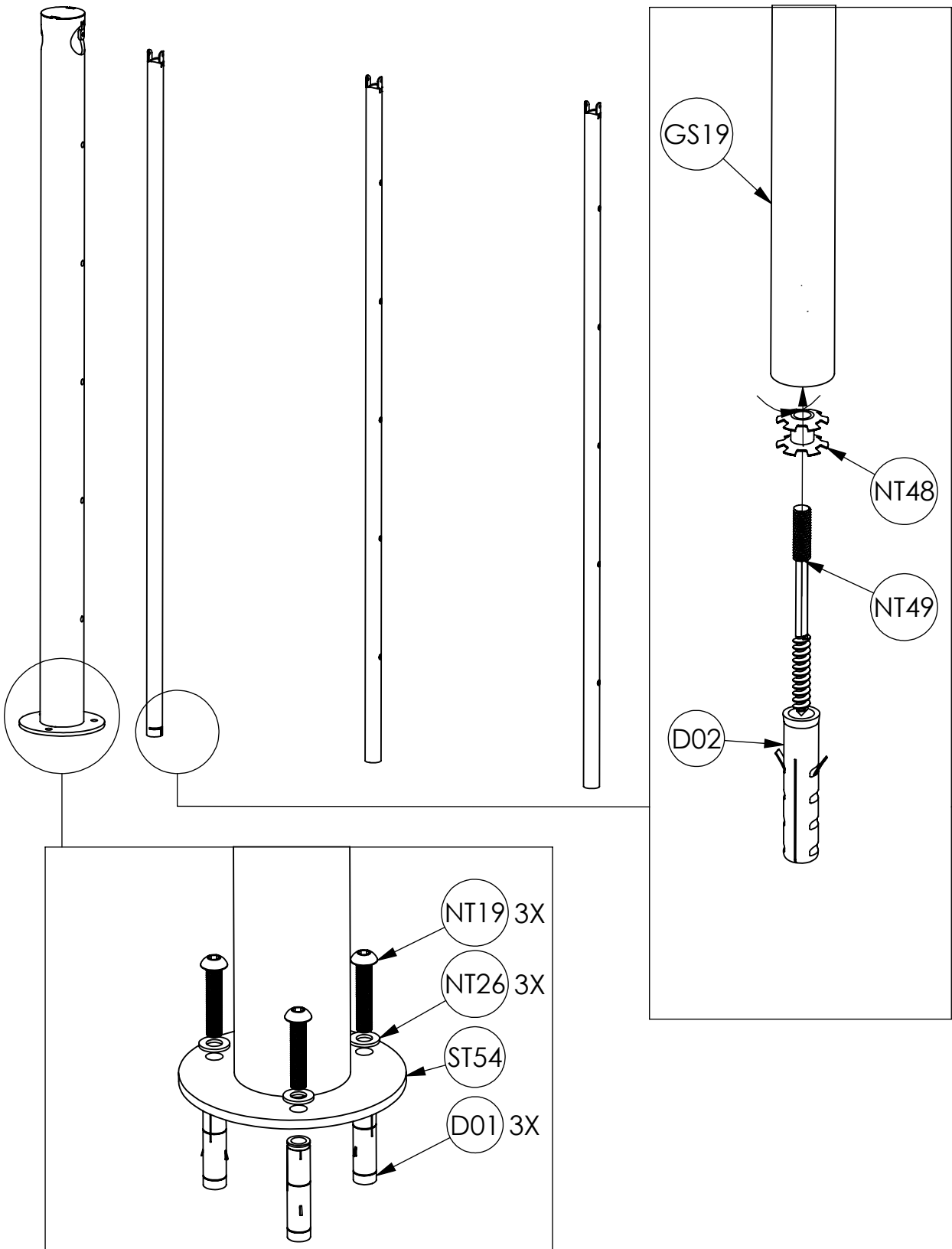
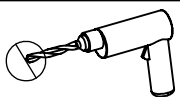
12 mm

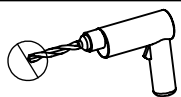

6 mm

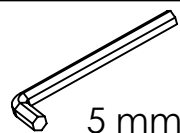
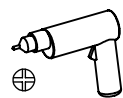

5 mm

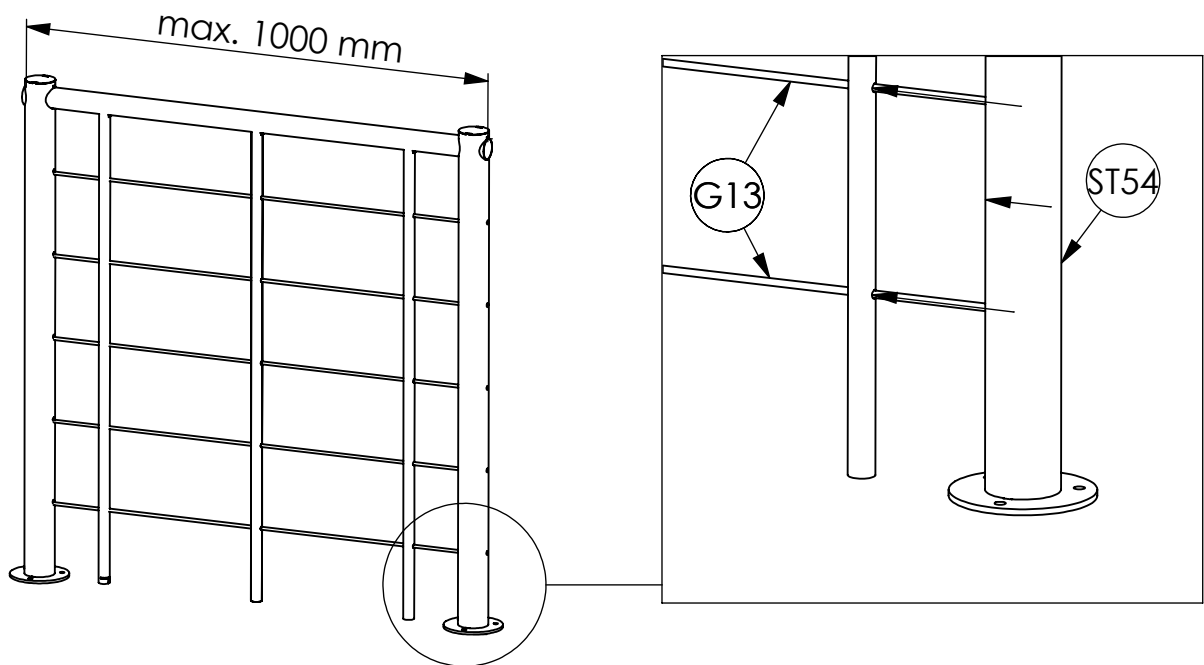
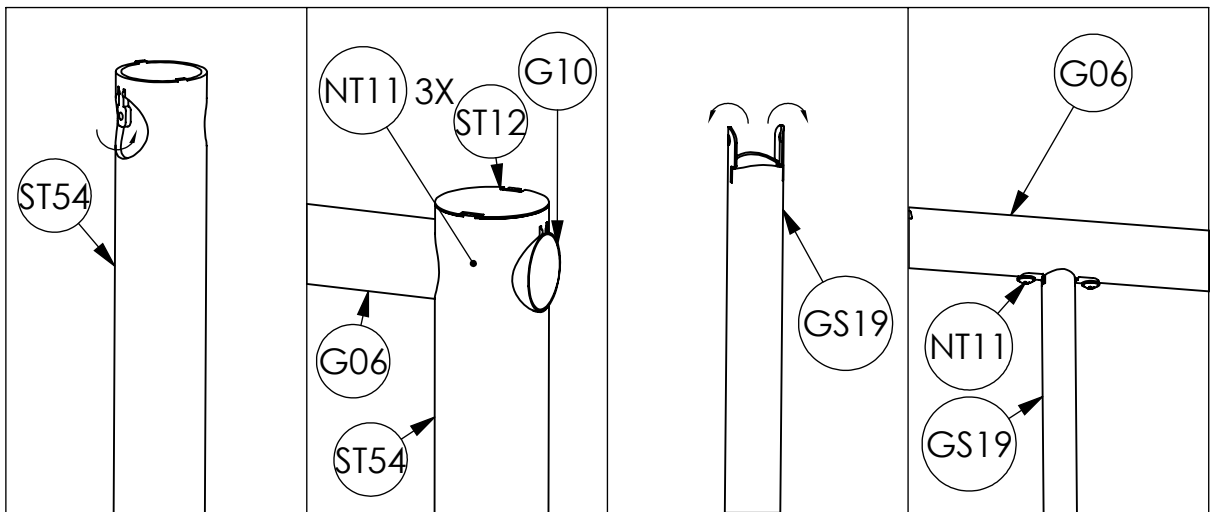

POSSIBILITY:

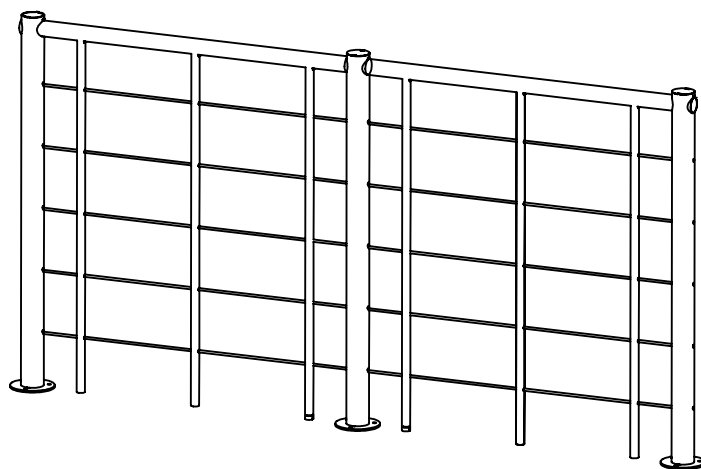

4

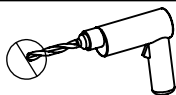
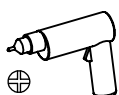

12 mm